

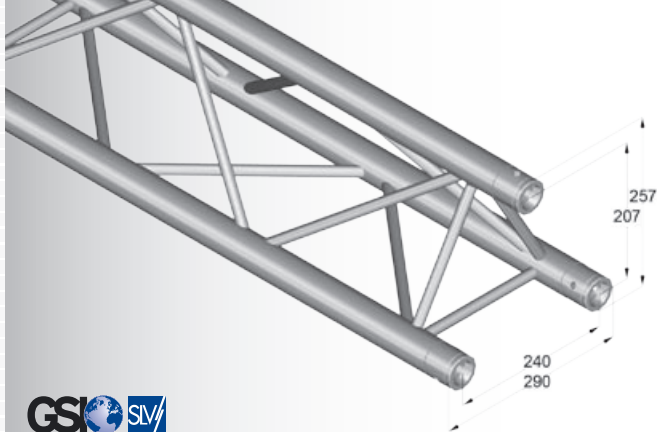

**TAF Schweiz**  
 Light Design Eventtechnik AG  
 Stückirain 10  
 3266 Wiler b. Seedorf

Tel: +41 32 391 60 70  
 Fax: +41 32 391 60 71  
 Mail: info@taf-truss.ch  
 Web: www.taf-truss.ch



# TQ-33

TQ 33 TRAVERSENSYSTEM (gerade Stücke)		
Bestellnummer	Artikelbezeichnung	Gewicht (kg)
RO-A3K30L500	Traverse (29x29cm) 50cm Länge	2,6
RO-A3K30L1000	Traverse (29x29cm) 100cm Länge	4,4
RO-A3K30L1500	Traverse (29x29cm) 150cm Länge	7,0
RO-A3K30L2000	Traverse (29x29cm) 200cm Länge	8,0
RO-A3K30L2500	Traverse (29x29cm) 250cm Länge	9,8
RO-A3K30L3000	Traverse (29x29cm) 300cm Länge	11,7
RO-A3K30L3500	Traverse (29x29cm) 350cm Länge	14,5
RO-A3K30L4000	Traverse (29x29cm) 400cm Länge	15,1
RO-A3K30L5000	Traverse (29x29cm) 500cm Länge	19,6

Gurtrohr	Streben	Werkstoff
50x2 mm	20x2 mm	EN-AW 6082 T6 (AlMgSi1 T6)

50 mm Durchmesser, Wandstärke 2 mm • 20 mm Durchmesser, Wandstärke 2 mm

Lade Tabelle	Punktlast [kg]	Beugung [mm]	UDL [kg/m]	Beugung [mm]
2m	600,0	2,97	750,0	4,8
4m	415,0	10,5	195,0	12,6
6m	270,0	16,8	98,0	29,0
8m	205,0	33,4	56,0	52,5
10m	160,0	50,8	35,0	82,2
12m	135,0	81,3	23,0	115,2

2 Weg Eckstück 45°      Gewicht 5,2 kg

1000 mm  
1000 mm

RO-A3K30J19

2 Weg Eckstück 60°      Gewicht 5,4 kg

1000 mm  
1000 mm

RO-A3K30J20

2 Weg Eckstück 90°      Gewicht 3,4 kg

500 mm  
500 mm

RO-A3K30J21

2 Weg Eckstück - vertical 60°      Gewicht 4,0 kg

500 mm  
500 mm

RO-A3K30J22

2 Weg Eckstück 135°      Gewicht 4,1 kg

500 mm  
500 mm

RO-A3K30J23

2 Weg Eckstück 90° - Spitze oben      Gewicht 3,2 kg

500 mm  
500 mm

RO-A3K30J24

2 Weg Eckstück 90° - Spitze unten Gewicht 3,7 kg

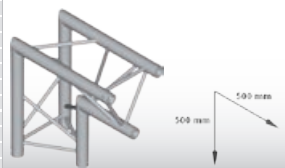

RO-A3K30J25

3 Weg Eckstück 90° - Spitze oben rechts Gewicht 5,1 kg

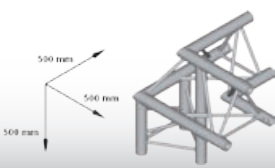

RO-A3K30J31

3 Weg Eckstück 90° - Spitze oben links Gewicht 5,1 kg

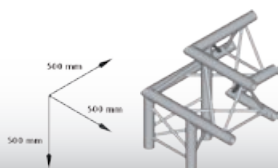

RO-A3K30J32

3 Weg Eckstück 90° - Spitze oben rechts Gewicht 5,1 kg

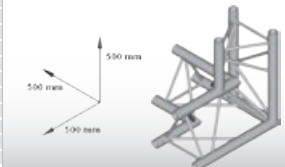

RO-A3K30J33

3 Weg Eckstück 90° - Spitze oben links Gewicht 5,1 kg

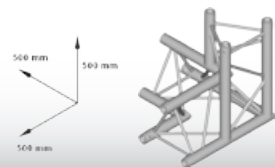

RO-A3K30J34

3 Weg T-Stück vertical - Spitze unten Gewicht 5,3 kg

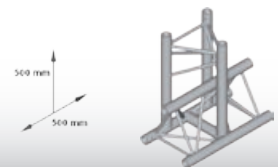

RO-A3K30J35

3 Weg T-Stück - horizontal Gewicht 4,6 kg

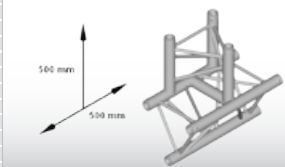

RO-A3K30J35 I

3 Weg T-Stück - horizontal Gewicht 4,6 kg

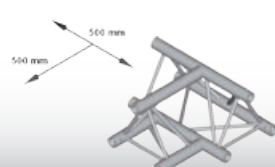

RO-A3K30J36

3 Weg T-Stück - vertical Gewicht 5,5 kg

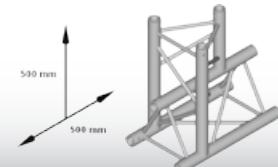

RO-A3K30J37

4 Weg Kreuzstück Gewicht 5,7 kg

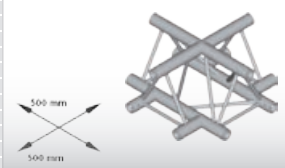

RO-A3K30J41

4 Weg T-Stück vertical - Spitze unten Gewicht 6,1 kg

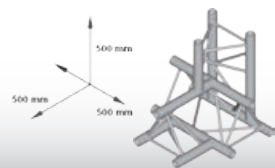

RO-A3K30J42

4 Weg T-Stück vertical - Spitze oben Gewicht 6,1 kg

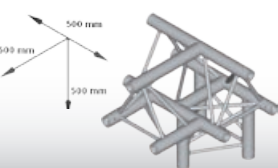

RO-A3K30J43

4 Weg Eckstück 90° / rechts Gewicht 6,5 kg

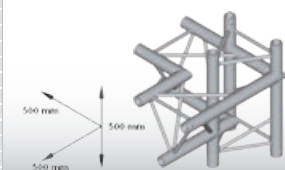

RO-A3K30J44

4 Weg Eckstück 90° / links Gewicht 6,5 kg

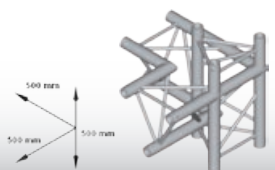

RO-A3K30J45

5 Weg T-Stück Gewicht 7,6 kg

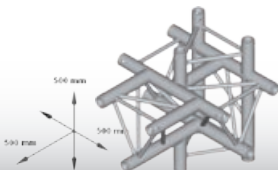

RO-A3K30J51

5 Weg Kreuzstück - Spitze oben Gewicht 7,2 kg

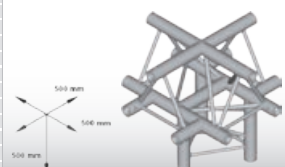

RO-A3K30J52

5 Weg Kreuzstück - Spitze unten Gewicht 7,2 kg

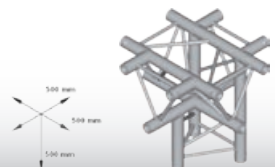

RO-A3K30J53

6 Weg T-Stück Gewicht 9,8 kg

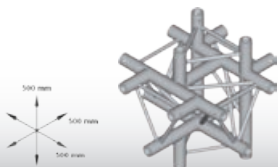

RO-A3K30J61