



## TAF Schweiz

Light Design Eventtechnik AG

Stückirain 10

3266 Wiler b. Seedorf

Tel: +41 32 391 60 70

Fax: +41 32 391 60 71

Mail: info@taf-truss.ch

Web: www.taf-truss.ch

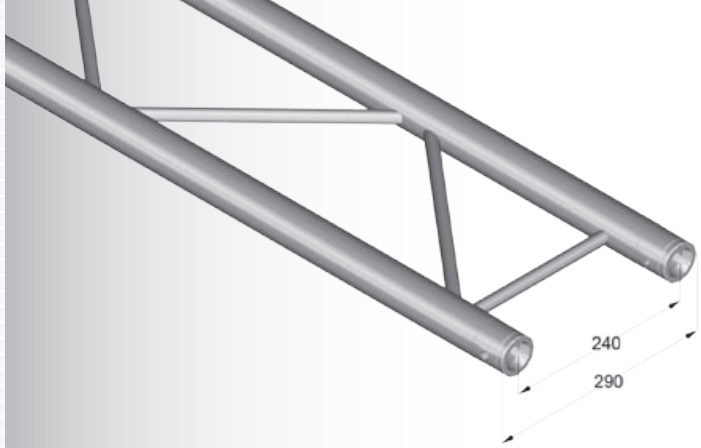

# TQ-32

Lade Tabelle	Punktlast [kg]	Beugung [mm]	UDL [kg/m]	Beugung [mm]
2m	1040,0	5,3	652,0	5,4
4m	500,0	13,3	219,0	16,2
6m	340,0	28,0	97,0	33,9
8m	250,0	47,7	58,0	58,2
10m	200,0	74,4	35,0	88,0
12m	160,0	104,5	25,0	126,1

Gurtrohr	Streben	Werkstoff
50x2 mm	20x2 mm	EN-AW 6082 T6 (AlMgSi1 T6)

50 mm Durchmesser, Wandstärke 2 mm  
20 mm Durchmesser, Wandstärke 2 mm

TQ 33 TRAVERSENSYSTEM (gerade Stücke)		
Bestellnummer	Artikelbezeichnung	Gewicht (kg)
RO-A2K30L500	Traverse (29x29cm) 50cm Länge	0,6
RO-A2K30L1000	Traverse (29x29cm) 100cm Länge	1,0
RO-A2K30L1500	Traverse (29x29cm) 150cm Länge	3,5
RO-A2K30L2000	Traverse (29x29cm) 200cm Länge	1,3
RO-A2K30L2500	Traverse (29x29cm) 250cm Länge	1,7
RO-A2K30L3000	Traverse (29x29cm) 300cm Länge	2,1
RO-A2K30L3500	Traverse (29x29cm) 350cm Länge	7,8
RO-A2K30L4000	Traverse (29x29cm) 400cm Länge	3,8
RO-A2K30L5000	Traverse (29x29cm) 500cm Länge	5,6

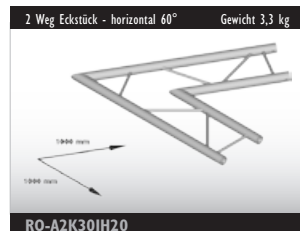
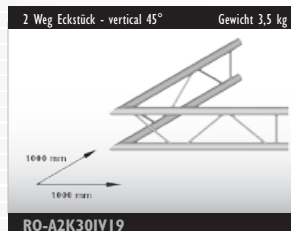
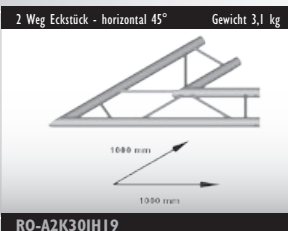

2 Weg Eckstück - vertical 60° Gewicht 3,5 kg

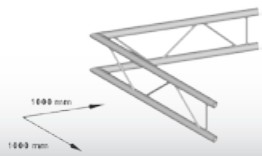

RO-A2K30JV20

2 Weg Eckstück - horizontal 90° Gewicht 2,4 kg



RO-A2K30JH21

2 Weg Eckstück - vertical 90° Gewicht 2,6 kg

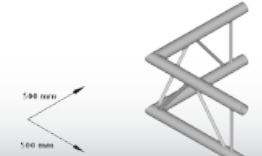

RO-A2K30JV21

2 Weg Eckstück - horizontal 120° Gewicht 2,7 kg

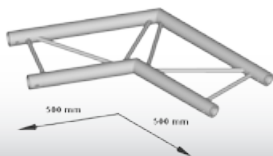

RO-A2K30JH22

2 Weg Eckstück - vertical 120° Gewicht 2,9 kg

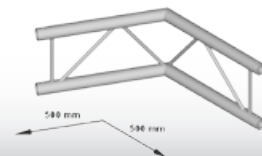

RO-A2K30JV22

2 Weg Eckstück - horizontal 135° Gewicht 2,8 kg

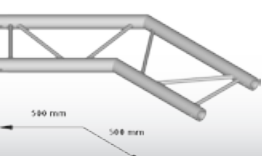

RO-A2K30JH23

2 Weg Eckstück - vertical 135° Gewicht 2,9 kg

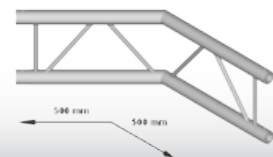

RO-A2K30JV23

3 Weg Eckstück - horizontal 90° Gewicht 3,9 kg

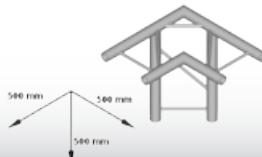

RO-A2K30JH31

3 Weg Eckstück - vertical 90° Gewicht 3,9 kg

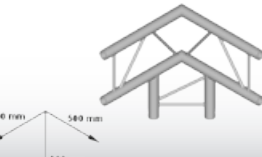

RO-A2K30JV31

3 Weg T-Stück - horizontal Gewicht 3,2 kg

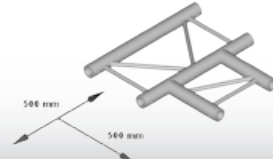

RO-A2K30JH36

3 Weg T-Stück - vertical Gewicht 3,4 kg

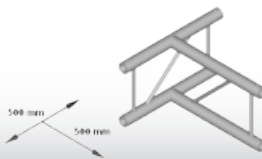

RO-A2K30JV36

4 Weg Kreuzstück - horizontal Gewicht 3,8 kg

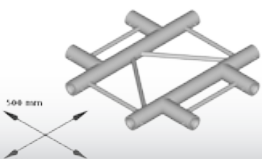

RO-A2K30JH41

4 Weg Kreuzstück - vertical Gewicht 4,0 kg

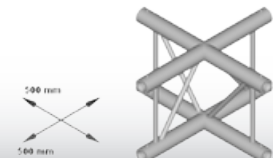

RO-A2K30JV41

4 Weg T-Stück - horizontal Gewicht 4,4 kg

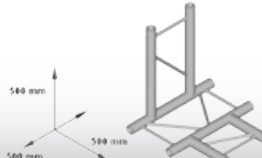

RO-A2K30JH42

4 Weg T-Stück - vertical Gewicht 4,4 kg

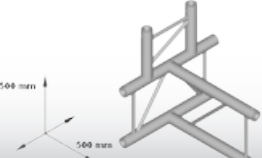

RO-A2K30JV42

4 Weg Ecke - horizontal Gewicht 4,4 kg

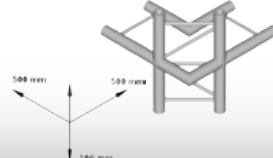

RO-A2K30JH44

4 Weg Ecke - vertical Gewicht 4,4 kg

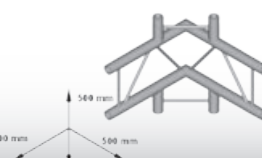

RO-A2K30JV44

TQ-32